

# 3D IMAGING



Planmeca Viso® family .....	4
Planmeca ProMax® 3D family.....	9
3D imaging – high image quality at an optimal patient dose .....	11
Ease of operation.....	12
Intelligent solutions for the best image quality .....	14
Proven low dose imaging.....	16
Professionals proudly present the Planmeca CBCT units .....	18
Planmeca Viso® .....	20
Planmeca ProMax® 3D Classic .....	22
Planmeca ProMax® 3D Plus .....	24
Planmeca ProMax® 3D Mid.....	26
Planmeca Romexis® – one software for all your needs.....	28
The advanced 3D software.....	30
The complete implant workflow .....	32
Share images and expertise online .....	34
Access to unique X-ray device data.....	35
Technical specifications .....	36

# Passion to innovate

An introduction from our President



“Welcome to the future of digital imaging. It gives me great pleasure to introduce you to our world-leading 3D X-ray units and **Planmeca Romexis®** imaging software – with a pioneering combination of 3D images that takes you closer for an even greater understanding of what your patients need.

I’m extremely proud of our product innovations, and for already half a century we’ve worked closely with dental professionals to set new standards in our field. What makes us a bit different is that all core product development and manufacturing takes place in Finland – ensuring exceptional quality and unmatched attention to detail at every stage of the process.

This brings us to our X-ray product family, taking care of all your 2D and 3D imaging needs in a single unit. Each product is a true all-in-one unit, offering easy-to-use controls and incredible patient comfort. We have a dedicated team of in-house R&D professionals behind the scenes, all determined to make the best possible products for you and your patients. Therefore I am thrilled to invite you to discover our complete selection of advanced 3D solutions.”

**Heikki Kyösti**  
 President and founder  
 Planmeca Group

# Planmeca Viso® family

The next generation has arrived

*Planmeca Viso® is an ideal combination of premium image quality and high-end usability. It possesses all the qualities of a world-class CBCT unit – and more. The unit is an impressive step forward in the evolution of cone beam imaging and fulfils all extraoral imaging needs from dental to demanding maxillofacial imaging in all clinical environments, be they private clinics or large hospitals.*



Maximum  
volume size  
Ø30 x 30 cm

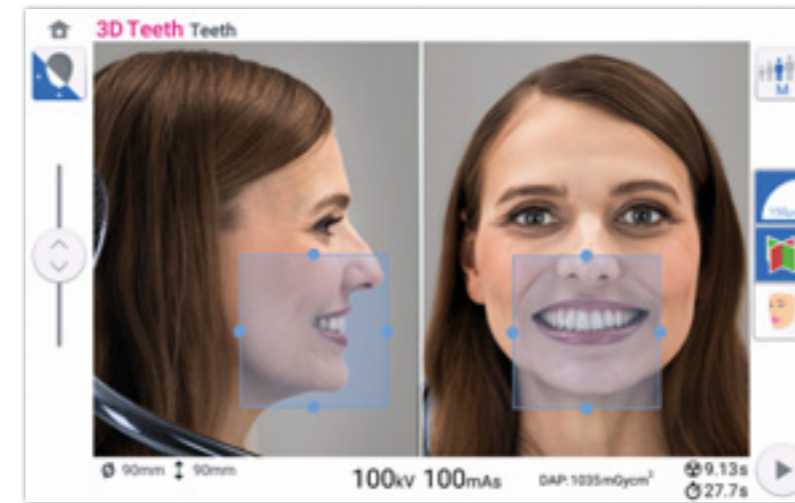

## Live virtual FOV positioning

Patient positioning is done directly from the CBCT unit's control panel using integrated cameras and a live patient view. Adjust the size and location of the FOV freely with just the tip of your fingers.

## Freely adjustable volume

Planmeca Viso® offers a wide selection of volumes to cover all clinical needs – from single tooth to full skull imaging. The volume size can be adjusted freely. The unit's remarkable 3D sensor is also fully capable of 2D imaging.

## Integrated face photo for improved patient communication

Planmeca Viso enables capturing highly detailed **Planmeca ProFace®** facial photos. It is a unique way of producing a realistic 3D face photo and a CBCT image with a single scan. The 3D face photo can also be created separately, without exposing the patient to any radiation.

## Intelligent patient support

The unit's occipital support provides stability without compromising patient comfort.



The size and location of the FOV can be further optimised in the scout view.

# Planmeca Viso® family

Our growing **Planmeca Viso®** CBCT imaging unit family now includes three models – all offering exceptional image quality, numerous cutting-edge features, and premium usability. The units are capable of three-dimensional imaging as well as panoramic, extraoral bitewing, and cephalometric imaging. The next generation of CBCT imaging is here in full force.

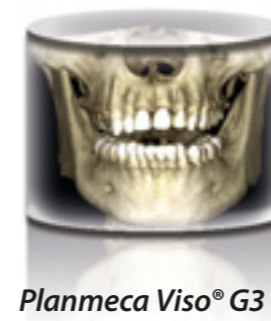

Planmeca Viso® G3



Planmeca Viso® G5



Planmeca Viso® G7

	G3	G5	G7
Maximum volume with a single scan	Ø20 x 10 cm	Ø20 x 10 cm	Ø30 x 20 cm
Maximum volume with multiple vertical scans		Ø20 x 17 cm	Ø30 x 30 cm
Planmeca Ultra Low Dose™ imaging	✓	✓	✓
Tube voltage 120 kV	✓	✓	✓
Endodontic mode	✓	✓	✓
3D dental programs	✓	✓	✓
3D ENT programs	✓	✓	✓
3D face photo	✓	✓	✓
2D panoramic imaging	✓	✓	✓
Cephalometric imaging, one-shot	✓	✓	✓

# Planmeca ProMax® 3D family

*Planmeca ProMax® 3D is a product family consisting of exceptional all-in-one units. With three different types of three-dimensional imaging – as well as panoramic, extraoral bitewing and cephalometric imaging – these intelligent products can meet all your everyday imaging needs.*



*Planmeca ProMax® 3D Classic*



*Planmeca ProMax® 3D Plus*



*Planmeca ProMax® 3D Mid*

	3D Classic	3D Plus	3D Mid
Maximum volume with a single scan	Ø8 x 8 cm	Ø20 x 10 cm	Ø20 x 10 cm
Extended volume with a single scan	Ø11 x 8 cm		
Maximum volume with multiple horizontal scans	15 x 10 x 8 cm		
Maximum volume with multiple vertical scans	Ø20 x 17 cm		
Planmeca Ultra Low Dose™ imaging	✓	✓	✓
Tube voltage option 120 kV		✓	✓
Endodontic mode	✓	✓	✓
3D dental programs	✓	✓	✓
3D ENT programs		✓	✓
3D face photo	✓	✓	✓
3D model scan	✓	✓	✓
SureSmile certification	✓	✓	✓
2D panoramic imaging	✓	✓	✓
Cephalometric imaging, scanning	✓	✓	✓
Cephalometric imaging, one-shot	✓	✓	✓

# 3D imaging – high image quality at an optimal patient dose

*When you need detailed information, CBCT imaging is the best way to see it all, giving a complete view of the pathology of interest. Discover our innovative range of 3D imaging units and enjoy the benefits of optimised workflows combined with high image quality – always at an optimal patient dose.*



# Ease of operation

Our intuitive patient positioning and imaging protocols ensure smooth and fast imaging workflows.

## Improved patient comfort

The open-face architecture of our imaging units offers both effortless positioning and an unrestricted view of the patient. At the same time, it allows the patient to feel comfortable without feeling closed-in while also accommodating wheelchair access through side entry.



## Intuitive use

The clear and straightforward graphical user interface guides you through the imaging process, while the ready-made imaging protocols save more time for your patients. For an even faster workflow, the control panel can also be operated remotely from the imaging workstation.



## Free 3D volume positioning

The 3D volume can be positioned freely and accurately for maximum flexibility.

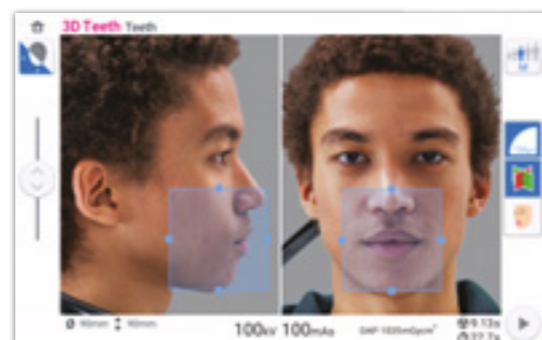

## Successful imaging every time

All our imaging units support taking scout images for perfect positioning to ensure successful imaging every time.

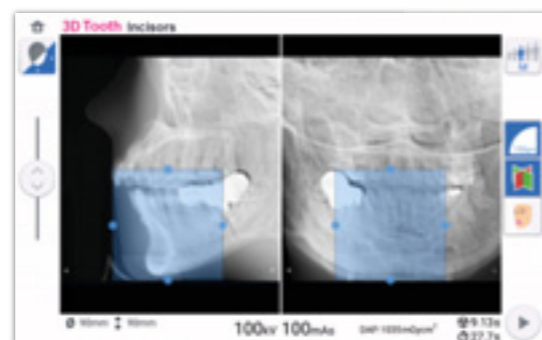

## 2D and 3D imaging with one sensor

There is no need to change sensors when alternating between CBCT and panoramic imaging. Our advanced SmartPan™ imaging system uses the same 3D sensor to acquire 2D images. Together with our intelligent Planmeca CORE™ pre-processing algorithm, they make the ideal solution for daily panoramic imaging.



# Intelligent solutions for the best image quality

Our intelligent high-tech solutions and algorithms guarantee an ideal imaging geometry, perfect usability, and crystal-clear images free from noise and artefacts.

## Flexible volume positioning

Our future-proof imaging platform is designed so that it can freely produce any movement pattern needed for optimal imaging results. This enables accurate and reliable volume positioning as well as volume diameter adjustment, reducing patient exposure to radiation.

## Ready-made imaging protocols

For your convenience, our imaging units offer ready-made imaging protocols for different diagnostic tasks. When necessary, you can easily adjust any parameter to your imaging needs.

## Optimised contrast for all patient images

The 120 kV tube voltage enables optimised image quality for even the most challenging areas of interest – reducing artefacts and ensuring better contrast images.

## Detailed endodontic imaging

All our CBCT imaging units support examining the finest anatomical details. The endodontic imaging mode allows capturing images with an extremely high resolution, with the 75 µm voxel size being perfect for visualising small details.

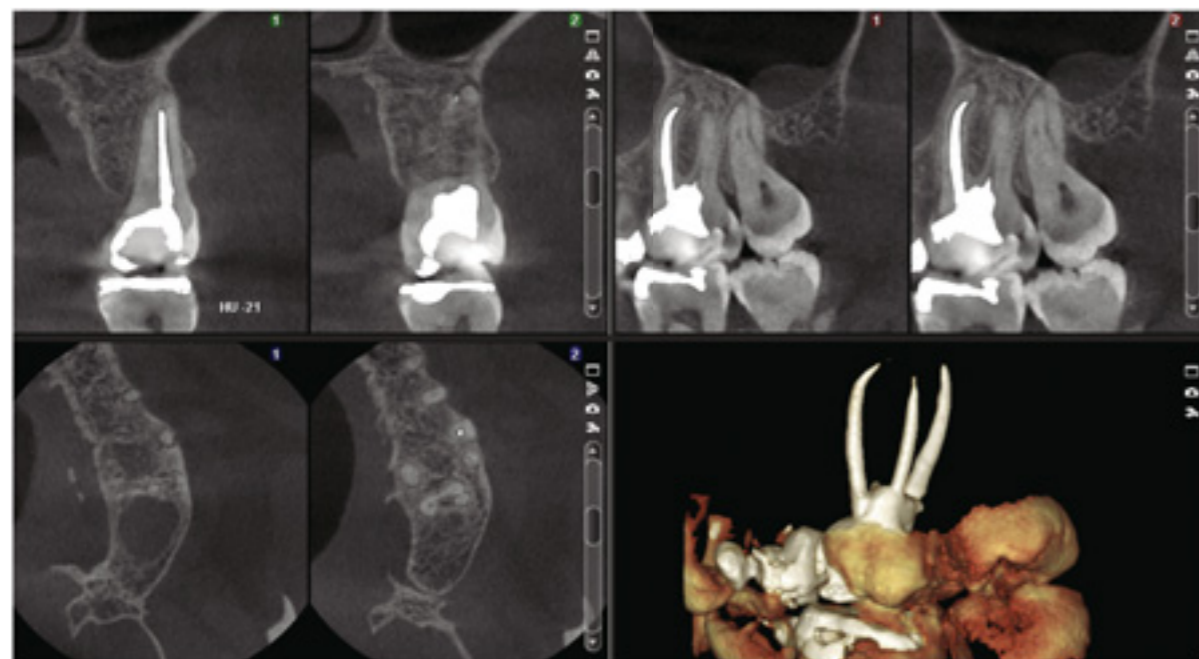

## Never miss a shot with Planmeca CBCT units

Movement, metal artefacts, and small voxel sizes are generally recognised as challenges to CBCT image quality. The advanced image enhancement options of Planmeca CBCT units enable you to rise above these concerns and succeed every time. These options can be either selected preventively before imaging or utilised afterwards for reliable results. The choice is yours!

## Patient movement correction with Planmeca CALM®

- Iterative movement correction algorithm
- Eliminates the need for retakes
- Cancels the effects of patient movement
- Excellent when imaging livelier patients



Without movement artefact correction



With the Planmeca CALM® movement removal algorithm

## Adjustable artefact reduction with Planmeca ARA™

- Reliable algorithm for artefact removal
- Removes shadows and streaks caused by metal restorations and root fillings
- Easy to adjust before or after imaging
- Tried and tested – result of extensive scientific research

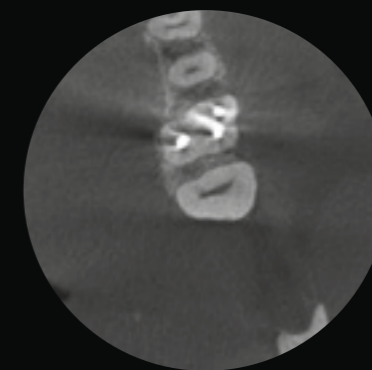

Without artefact removal



With the Planmeca ARA™ artefact removal algorithm

## Noise removal with Planmeca AINO™

- Reduces noise in images while preserving important details
- Allows lower exposure values by reducing noise
- Improves image quality when using small voxel sizes (e.g. in the endodontic imaging mode)
- Enabled by default when using the Planmeca Ultra Low Dose™ imaging protocol

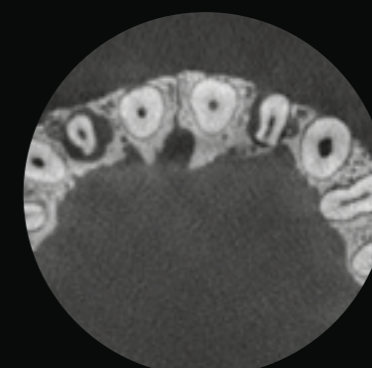

Without noise removal

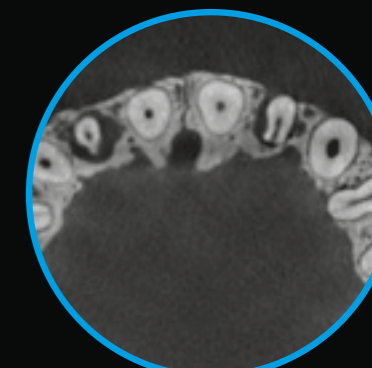

With the Planmeca AINO™ noise filter



# Proven low dose imaging

Our 3D X-ray units offer a unique **Planmeca Ultra Low Dose™** imaging protocol that enables CBCT imaging with an even lower patient radiation dose than standard 2D panoramic imaging.



## Remarkably lower patient doses

The **Planmeca Ultra Low Dose™** (ULD) protocol decreases the exposure values and thus the patient dose at the same time as Planmeca's other intelligent 3D imaging algorithms maintain the image quality at a diagnostically acceptable level – all to achieve the optimal balance between image quality and patient dose.

Our ULD protocol allows achieving up to six times lower effective doses compared to standard protocols.\*

## Scientifically proven

Planmeca ULD helps clinicians adhere to the ALADA (As Low As Diagnostically Acceptable) principle in their practice and is ideal for a wide range of clinical cases, from implant planning to orthodontics. But don't just take our word for it – the use of Planmeca ULD and its benefits have been studied and scientifically proven in a number of scientific studies.

[planmeca.com/ULD-studies](https://planmeca.com/ULD-studies)



\*Charuakra, A., Mahasantipiya, P., Lehtinen, A., Koivisto, J., Järnstedt, J. (2022). Comparison of subjective image analysis and effective dose between low-dose cone-beam computed tomography machines. Dentomaxillofacial Radiology. <https://doi.org/10.1259/dmfr.20220176>

## The Planmeca Ultra Low Dose™ protocol has changed 3D imaging completely

We at MESANTIS® 3D DENTAL-RADIOLOGICUM produce about 7,500 CBCT images per year at eight locations in Germany.

Our main concern in X-ray imaging is how to reduce the radiation dose as much as is reasonably achievable (ALARA principle). Traditional digital 2D X-rays at an orthodontist's clinic usually have an effective dose ranging between 26–35 µSv (ICRP 2007). Conventional CBCT images of the head with modern CBCT equipment have an effective dose ranging between 49–90 µSv.

One imaging protocol with a specific associated algorithm is called the **Planmeca Ultra Low Dose™** protocol. In medical terms, it allows radiologists to adjust imaging parameters individually according to the clinical needs of each case. The mA-values, in particular, can be individually adjusted and reduced

for each patient, as required by all international scientific guidelines. Therefore, it is possible to significantly reduce the effective dose even further with the Planmeca Ultra Low Dose protocol. Depending on the field of view, nowadays CBCT equipment with the Planmeca Ultra Low Dose algorithm has an effective dose between 4–22 or 10–36 µSv.

Our patients and referring colleagues are always happy to hear that the effective dose for certain indications is now even lower than in traditional 2D X-ray imaging. Since last year, we have been able to replace the common CBCT protocols with the Planmeca Ultra Low Dose protocol.

Prof. Dr. Axel Bumann

Prof. Dr. Bumann declares that he has not received any financial reward or other benefit for this interview.



Planmeca ProMax® 3D Mid

- FOV Ø20 x 17 cm / voxel size 600 µm
- Effective patient dose 14.7 µSv

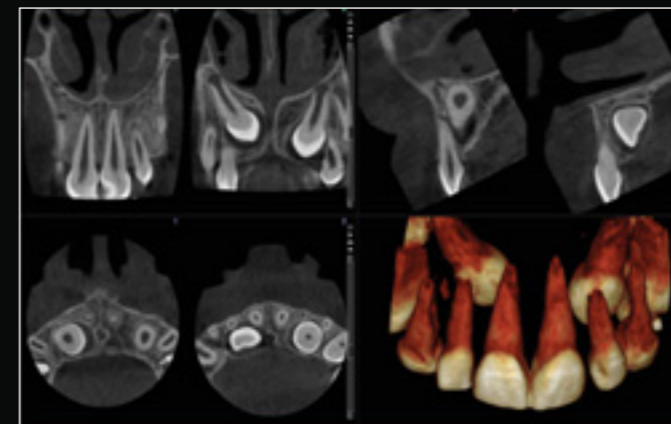

Planmeca ProMax® 3D Classic

- FOV Ø4 x 5 cm / voxel size 150 µm
- Effective patient dose 14.4 µSv

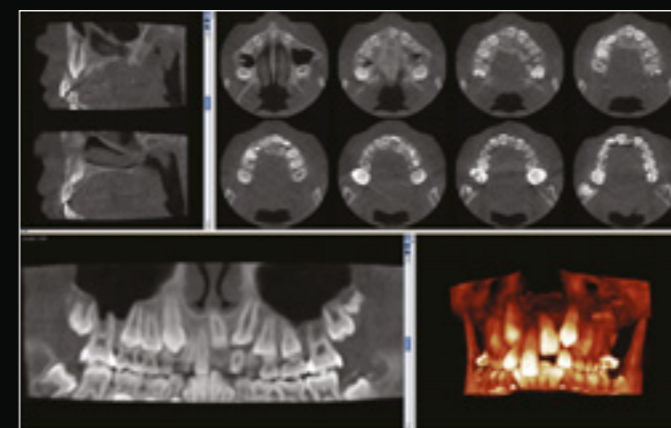

Planmeca ProMax® 3D Mid

- FOV Ø8.5 x 5 cm / voxel size 400 µm
- Effective patient dose 4.0 µSv

Prof. Dr. Axel Bumann  
DDS, PhD, Orthodontist,  
Oral Surgeon, Oral and  
Maxillofacial Radiology

# Professionals proudly present the Planmeca CBCT units



## Which one is right for you?

### Planmeca Viso® G3

The newest member of our 3D family, **Planmeca Viso® G3**, offers premium imaging of the whole dentition and comes with the full benefits of Viso technology, from innovative patient positioning to fantastic usability.

### Planmeca Viso® G5

**Planmeca Viso® G5** enables imaging beyond the dentition with its range of ENT programs. A wide selection of volume sizes and outstanding usability offer even more flexibility for a variety of imaging needs.

### Planmeca Viso® G7

A state-of-the-art CBCT unit that perfectly meets all the needs and requirements of extraoral imaging – offering freely adjustable volume sizes from 3 x 3 to 30 x 30 cm.

### Planmeca ProMax® 3D Classic

The imaging sensor of **Planmeca ProMax® 3D Classic** covers the whole dentition and gives a clear view of the mandible and maxilla.

### Planmeca ProMax® 3D Plus

**Planmeca ProMax® 3D Plus** offers a wide variety of volume sizes and is a great choice for any imaging needs.

### Planmeca ProMax® 3D Mid

Thanks to its wide selection of volume sizes, **Planmeca ProMax® 3D Mid** easily handles a range of diagnostic tasks with no compromises in best practices.

The interviewed have not received any financial compensation or other benefit for the interviews that follow.

# Planmeca Viso®



## Versatile and flexible imaging with Planmeca Viso®

### Dr Alvaro Ordonez, DDS

South Miami Family Dental  
Florida, United States

"Our practice is an advanced TMD/facial pain centre. We also provide comprehensive dental services which include restorative procedures, implants and endodontic work. So, we needed a versatile system with large and small volume sizes.

After a thorough research process, we decided to acquire the new **Planmeca Viso® G7**. It offered the flexibility we required as well as advanced imaging critical for our unique needs."



## Excellent image quality and low patient doses truly matter



### Dr Antero Salo

Qmedical  
Helsinki, Finland

"For years, we have been participating in clinical imaging trials conducted by Planmeca. There's such a positive vibe to this cooperation. Planmeca takes genuine pride in their product know-how, and that is just a great thing to watch.

We have been among the first to try out new technology. In fact, I was the first **Planmeca Viso®** user in the whole world. We now have both the G7 and G5 versions of the CBCT unit.

The best part of Planmeca Viso is its excellent image quality and the low patient doses enabled by the unit. These are things that truly matter. We use the **Planmeca Ultra Low Dose™** protocol, and with the huge leaps made in imaging technology, the risks associated with radiation exposure have diminished considerably, especially compared to when we first started CBCT imaging around 15 years ago. Nowadays, we can often make an imaging decision based on the indication – not the amount of radiation."

### Volume range

- G3: Ø3 x 3 – Ø20 x 10 cm
- G5: Ø3 x 3 – Ø20 x 17 cm
- G7: Ø3 x 3 – Ø30 x 30 cm

- Planmeca Ultra Low Dose™ imaging ✓
- Tube voltage 120 kV ✓
- Endodontic mode ✓
- 3D dental programs ✓
- 3D ENT programs ✓
- 3D face photo ✓
- 2D panoramic imaging ✓
- Cephalometric imaging, one-shot ✓



# Planmeca ProMax® 3D Classic



## Finnish dental clinic chooses Planmeca

**Dr Pekka Nissinen, GPD, &  
Dr Kim Lemberg, DDS, PhD**  
Specialist in Oral and Maxillofacial Radiology  
West Vantaa Dental Clinic, Finland

“We decided to purchase a Planmeca ProMax® 3D Classic for our clinic as we wanted to start taking our own CBCT images. We did not want to have to send our patients elsewhere to have their 3D X-rays taken, because in such cases, there is always the risk that the treatment process suffers due to the patient’s lack of activity. Now we have our own radiologist and things go very smoothly. We also have two surgeons working with us, as we do a lot of implant treatments and also treat difficult endodontic cases.”

### Implant case acceptance skyrocketed

“After acquiring the Planmeca ProMax 3D Classic, the amount of implant cases treated at our clinic has increased considerably. Patients are always amazed when we offer to take their 3D images straight away. The unit is also well suited to complicated endodontic cases, as you can see everything in a 3D volume. It is also excellent for cases in which the wisdom teeth have grown at a cumbersome angle.

The image quality produced by Planmeca ProMax 3D Classic is excellent. I think it is safe to say that we have the best 3D unit in Finland. This opinion is shared by our surgeons and many radiologists as well.

The Planmeca Romexis® software is a great working tool. It is logical, easy to use, and functions well – just a really good piece of software.”



## With 3D, I’m much more prepared and know exactly what to expect

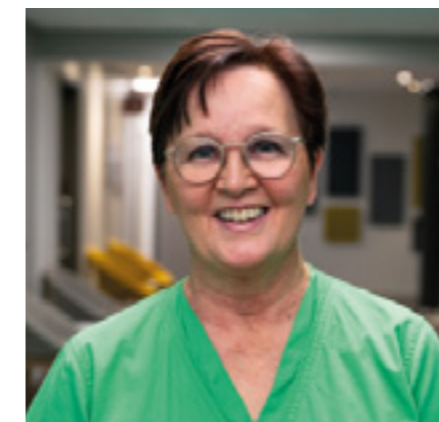

**Dr Sirpa Pöyry**  
Specialist in Endodontics  
Helsinki, Finland

“The structures are very narrow in root canal treatments. Before 3D imaging, it was sometimes hard to determine the number and shape of all the roots, as 2D images did not always provide sufficient information. Now, I can navigate in 3D, look at the complete structure and gain a good understanding of the area of interest – down to every individual root. When the treatment starts, I’m much more prepared and know exactly what to expect.”

### Volume range

Ø5 x 5 cm – 15 x 10 x 8 cm

Planmeca Ultra Low Dose™ imaging	✓
Endodontic mode	✓
3D dental programs	✓
3D face photo	✓
3D model scan	✓
SureSmile certification	✓
2D panoramic imaging	✓
Cephalometric imaging, scanning	✓
Cephalometric imaging, one-shot	✓

### Extended volume

The extended volume size increases the diameter from Ø8 x 8 cm to Ø11 x 8 cm, capturing a larger diagnostic area without increasing the patient dose.

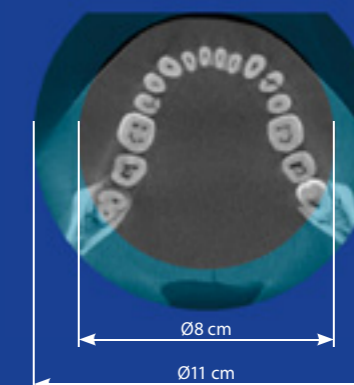

# Planmeca ProMax® 3D Plus



## German oral surgery practice is impressed with the image quality of Planmeca ProMax® 3D Plus

### Dr Dirk Ladig

Oral surgery practice  
Hoyerswerda, Germany

"I have been using the Planmeca ProMax® 3D Plus unit in my oral surgery practice since 2013. Before that, I had had good experience with Planmeca X-ray units. My panoramic X-ray unit ran smoothly for 19 years, the service was good and I was satisfied. Moreover, in 2000, I integrated cone beam computed tomography into my practice by adding a second unit. The decisive factor in purchasing the Planmeca ProMax 3D Plus unit was the radiographs of the new flat-panel devices shown to me by my colleagues. The higher resolution of the images was very impressive! There was also a change in the physical layout of my practice. Instead of having two X-ray rooms, I wanted to have one. Planmeca ProMax 3D Plus combines two devices in one: OPG and CBCT. As a result, we need considerably less space."

### More information in a single image

"I use the device for different kinds of treatment planning, mainly implant cases but also high-risk wisdom tooth surgery. In my view, one key benefit of the Planmeca ProMax 3D Plus is being able to display the entire mandible – including the ascending mandibular ramus and mandibular joint – in a single image. I also use the images for diagnosing foreign body locations, apical variances as well as inflammatory processes in the jaw area. CBCT provides much better diagnostic options for screening for infectious foci in patients with unclear symptoms or certain systemic diseases. Questions related to orthodontic treatments of impacted and displaced teeth, for example, can be easily solved on behalf of colleagues."



### Low radiation exposure with adjustable volume sizes

"What I really like about the unit is that I can select the volume according to the image required. Thus, the patient's exposure to radiation is kept as low as possible. I use low-dose scans particularly with orthodontic diagnosis. The layer lights are especially useful when centring the image volume."

Operating and adjusting the unit is easy. What's more, the transition from analogue to digital control went well. Since the patients stand upright within the unit, positioning is much easier than with the predecessor to the CBCT model (with the patient bench), without any problems with motion blur. The new device is also much more pleasant for the patient because there is no feeling of confinement."

### Volume range

Ø4 x 5 cm – Ø20 x 10 cm

Planmeca Ultra Low Dose™ imaging	✓
Tube voltage option 120 kV	✓
Endodontic mode	✓
3D dental programs	✓
3D ENT programs	✓
3D face photo	✓
3D model scan	✓
SureSmile certification	✓
2D panoramic imaging	✓
Cephalometric imaging, scanning	✓
Cephalometric imaging, one-shot	✓



# Planmeca ProMax® 3D Mid



## Italian A&P Clinic opts for Planmeca ProMax® 3D Mid after a thorough market analysis

**Dr Carlo Pizzo, DDS, & Dr Gioia Amico, DDS**

**A&P Clinic  
Cittadella, Italy**

"In our new dental clinic, we have the **Planmeca ProMax® 3D Mid** imaging unit – and we are really satisfied with it.

We chose the unit after a thorough analysis of what the market had to offer. We needed an imaging unit that could provide a wide range of FOV choices, the option of taking panoramic images and cephalometric shots, and, last but not least, software that could run natively on Mac OS, because our IT infrastructure was entirely built on Apple computers. The only unit that fulfilled all of these requirements was Planmeca ProMax 3D Mid."

### For every clinical application

"We love using it for taking panoramic images, preliminary treatment planning, 3D scans, wisdom teeth extractions and implant surgery. With **Planmeca Romexis®** – its dedicated software – we can virtually place the exact dental implants we are going to use by choosing them from the integrated 3D implant library. This feature works amazingly well."

### 3D magic with the latest technology

"The machine and the software work seamlessly together: they are fast, reliable and easy to use. The 3D rendering is an incredibly powerful tool for us – for visualising the real bone morphology of the patients, and for the patients themselves



to better understand their clinical situation and the treatment we are offering them. As a result, Planmeca Romexis can be a really effective communication tool. For this reason, we also adopted the **Planmeca ProFace®** option. By superimposing a 3D scan of the patient's face on the CBCT image, we can show our clients an easy-to-understand image in which they can really recognise themselves. Even today, this is like magic for many of our patients!"

### Volume range

Ø4 x 5 cm – Ø20 x 17 cm

Planmeca Ultra Low Dose™ imaging	✓
Tube voltage option 120 kV	✓
Endodontic mode	✓
3D dental programs	✓
3D ENT programs	✓
3D face photo	✓
3D model scan	✓
SureSmile certification	✓
2D panoramic imaging	✓
Cephalometric imaging, scanning	✓
Cephalometric imaging, one-shot	✓



# Planmeca Romexis® – one software for all your needs



We offer a revolutionary all-in-one software solution for clinics of all sizes. Our unique Planmeca Romexis® software supports all types of dental imaging – from 2D and 3D to CAD/CAM – and offers an extensive range of tools for all specialities and specialist. All patient images are available in one easy-to-use user interface and stored in one database.



- 2D imaging
- 2D cephalometry
- 3D imaging
- 3D cephalometry
- Smile Design
- CAD/CAM
- 3D implantology
- CMF Surgery



Mac\* and Windows compatible



\*Some features only supported in Windows operating systems.

# The advanced 3D software

Our pioneering **Planmeca Romexis®** software offers specially designed tools for implantologists, endodontists, periodontists, prosthodontists, orthodontists, maxillofacial surgeons, and radiologists. You can also view your images wherever you are using our mobile apps, and enjoy unmatched compatibility with other systems.

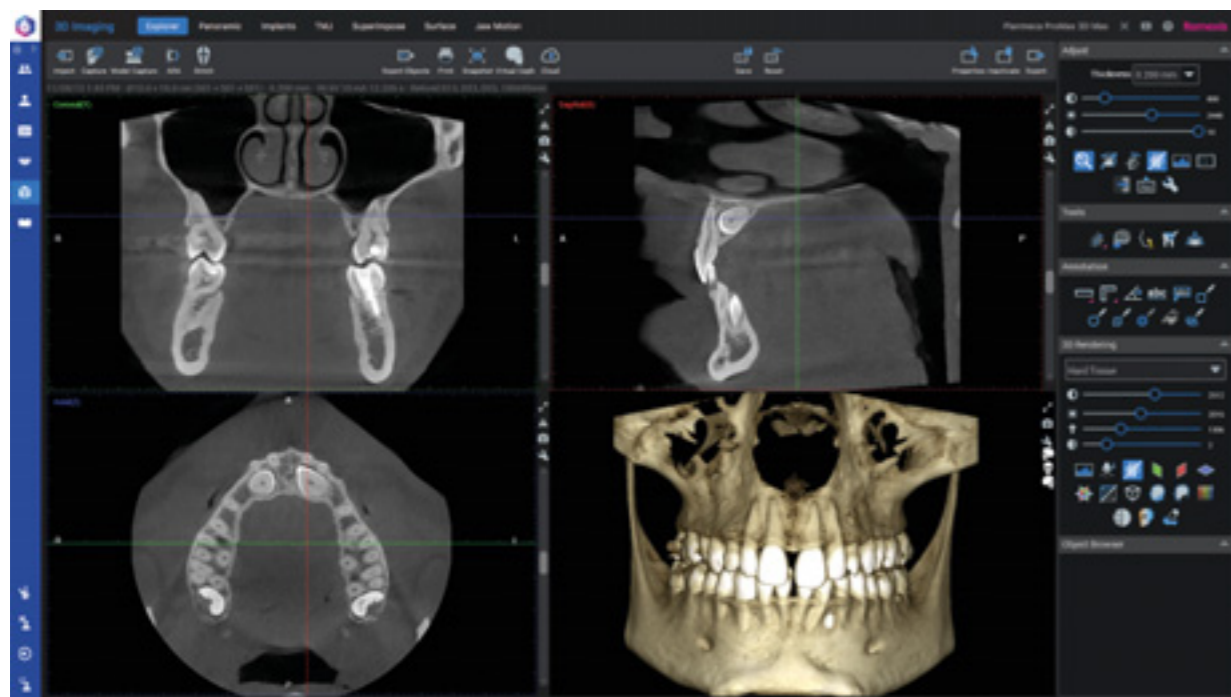

## Excellent tools for quality images

With a complete set of tools for image viewing, enhancement, measurement, drawing and annotations, **Planmeca Romexis®** improves the diagnostic value of radiographs. Versatile printing and image import and export functionalities are also included. The software consists of different modules – so you can choose those most suited to your needs.

## Convenient 3D diagnosis

The Planmeca Romexis 3D rendering view gives an immediate overview of the anatomy and serves as an excellent patient education tool. The images can be instantly viewed from different projections or converted into panoramic and 2D cephalometric images, cross-sectional slices and TMJ views. Measuring and annotation tools – such as nerve canal tracing – assist in safe and accurate treatment planning.

## Best compatibility with other systems

Planmeca Romexis offers excellent compatibility with other systems, allowing you to freely use third-party products at your clinic. TWAIN support and DICOM standard compliance ensure that our flexible software can be used effortlessly with most systems.

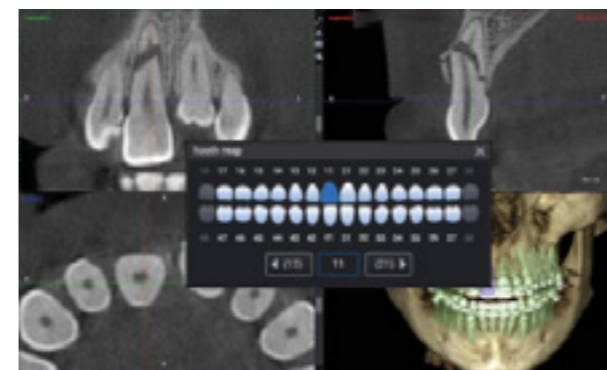

## Intelligent navigation

Thanks to the automatic tooth number recognition, a CBCT volume can be easily navigated by just clicking on tooth numbers. Planmeca Romexis automatically centres all views on the tooth of interest.

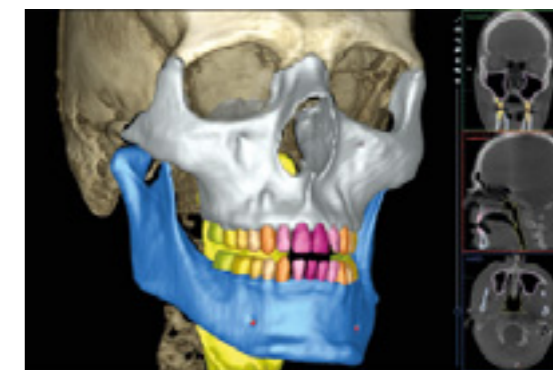

## Automatic segmentations

With the Planmeca Romexis Smart feature, airways, jaws, teeth, sinuses and nerves are automatically segmented. The segmented anatomies are ideal for patient education and can also be exported as STL for 3D printing, for example.

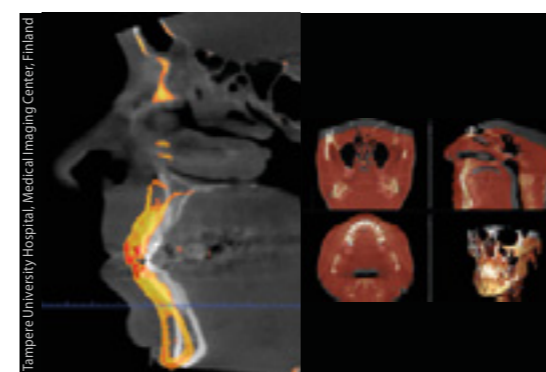

## Superimpose CBCT

Planmeca Romexis allows the superimposition of two CBCT images. It is a valuable tool for before-and-after comparisons and can be used for orthognathic surgery follow-ups, as well as orthodontic treatments, for example.

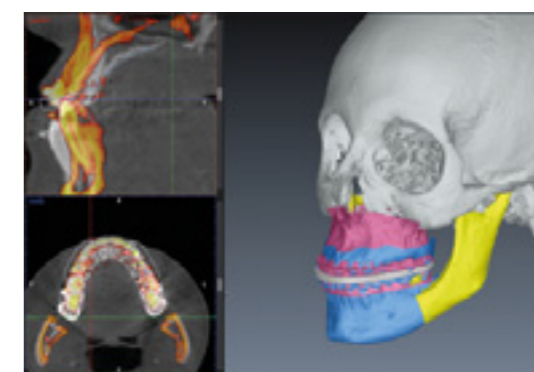

## Orthognathic surgery

With the **Romexis® CMF Surgery** module, surgeons can virtually plan the orthognathic surgery and design final and intermediate splints. The software includes ready-made virtual cutting templates for one-piece Le Fort I, two-piece Le Fort I and three-piece Le Fort I for the maxilla and BSSO Hunsuck, BSSO Obwegeser, Inverted L, vertical ramus and Genioplasty for the mandible.



## Shaping tool for 3D face photo

The shaping tool allows for free modification of **Planmeca ProFace®** surfaces to simulate effects of treatments or surgery, for example.



## 3D cephalometry

The **Romexis® 3D Cephalometry** module allows performing cephalometric tracing and analysis in 3D. The placing of anatomical landmarks is done intuitively either on 3D or 2D slice views. The module includes two analysis types: TFA Perrotti Analysis and Orthognathic Surgery Analysis.



# The complete implant workflow

Our **Planmeca Romexis® 3D Implant Planning** module offers all the necessary tools for fully digital implantology – from planning to guided surgery. The software's implant library includes realistic implant models as well as collections of sleeves for guided surgery. After completing the implant plan, a surgical guide can be immediately designed in the same **Planmeca Romexis®** software with just a few clicks.

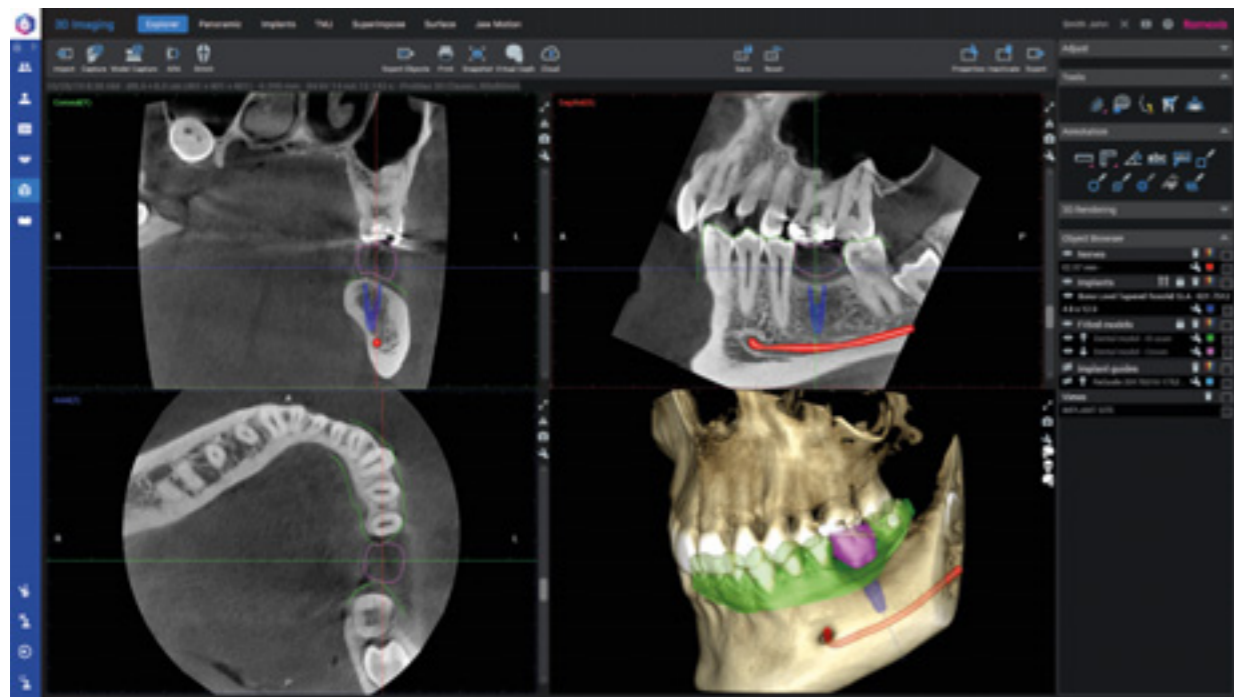

The **Planmeca Romexis®** software platform provides the perfect environment for top-down implant planning. By superimposing a crown and dental model onto CBCT data, users can create a complete virtual setup for optimally positioning the implant – taking prosthodontic and surgical perspectives into account.

**Realistic implant models from over 120 manufacturers**

See a constantly growing list of all the implants included in the Romexis implant library at [planmeca.com/Romexisimplantlibrary](http://planmeca.com/Romexisimplantlibrary)

## Top-down implant workflow



**1** Mark the nerve on the CBCT image

Superimpose the 3D model scan onto the CBCT image with the Planmeca Romexis® software



**2** Use the Planmeca Romexis® crown library, or import a patient-specific crown from the CAD system to the software

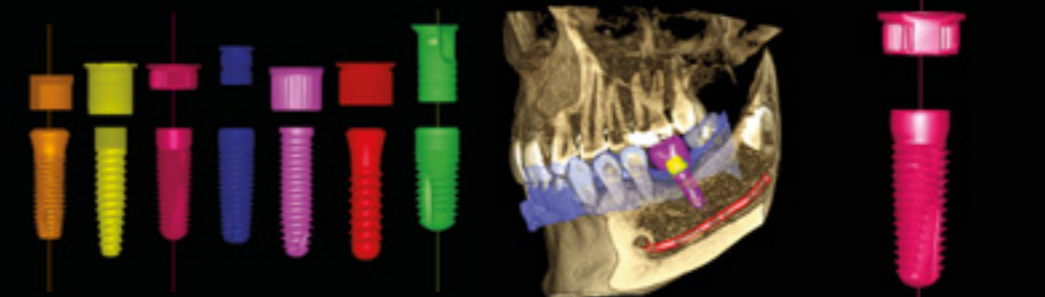

**3** Select the preferred implant and sleeve from the extensive Planmeca Romexis® library and find the optimal position for it from a prosthetic and surgical perspective

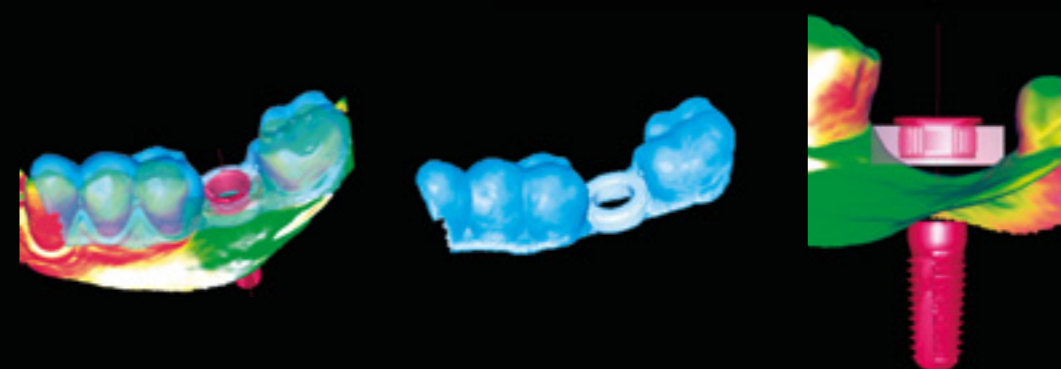

**4** Design the surgical implant guide with just a few clicks in Planmeca Romexis® – the software will create an open STL file of the design

Romexis allows designing both tooth- and mucosa-supported guides.



**5** Print the surgical guide with Planmeca Creo® C5 or any other suitable 3D printer.



# Share images and expertise online

*Planmeca Romexis® Cloud is a secure image transfer service for Planmeca Romexis® users and their partners for sharing image and patient data with any specialist, dental lab or patient. You can share images and expertise securely with all partners who use Planmeca Romexis, the free Planmeca Romexis® Viewer, the free Planmeca Romexis® LabApp or the Planmeca mRomexis™ mobile tablet application.*

## Romexis® Cloud – versatile possibilities for communication

- External applications, DVDs and insecure file transfers are history – images can be sent directly from Planmeca Romexis®
- Share images and data with your dental partners and patients
- The Romexis software and Planmeca Romexis® Cloud subscriptions are required to send new cases – recipients only need an e-mail account at minimum

### Key features

#### Transfer any type of information

- Images: 2D, 3D, STL
- Referrals and interpretations
- Treatment plans

#### Flexible sending options enable easy communication with all parties

- From Romexis to Romexis
- From Romexis to Romexis LabApp
- From Romexis to email
  - Optionally include the free Romexis Viewer for the easy viewing of images by anyone
- From Romexis to Planmeca mRomexis

Visit [online.planmeca.com](http://online.planmeca.com) to subscribe and start sending images now.

### IMAGING WORKFLOW



#### Planmeca equipment owner

- Romexis software
- Romexis Cloud subscription

#### General practice, specialist, radiologist

- Free Romexis Viewer application or Romexis

### CAD/CAM WORKFLOW



#### General practice

- Romexis software
- Romexis Cloud subscription

#### Dental lab

- Free Romexis LabApp application



### Increased flexibility with Planmeca mRomexis™ tablet application

Use our fast, easy, and light Planmeca mRomexis™ mobile imaging application to view all your images in the Planmeca Romexis database on a local network, or to carry images with you on your tablet device. You can also use the application to take photos with the tablet camera.

Download the Planmeca mRomexis application for iOS and Android from the [App Store](#) or [Google Play](#).

### View images with free Romexis® Viewer application

Planmeca Romexis® Viewer is a free application that can be exported and sent together with images from Romexis.

- Full-featured viewer application for 2D and 3D images
- No installation required
- Mac and Windows support
- Distribute to specialists or patients

Visit [planmeca.com/Viewer](http://planmeca.com/Viewer) for downloading Planmeca Romexis Viewer application.

### Dental lab communication with free Romexis® LabApp application

Planmeca Romexis® LabApp is a free application designed for dental laboratories to allow easy communication with dental clinics. It is designed especially for receiving intraoral scans but can be used for all types of image data. It uses Romexis Cloud as transfer service providing secure transfer of patient data.

- Receiving STL files, PLY scans, DICOM images, photos and PDF files from Planmeca Romexis users
- Instant viewing of STL and PLY files for checking
- Exporting all case data to a 3<sup>rd</sup> party dental CAD/CAM system
- Messaging between the lab and the clinic using the built-in case messaging

Visit [online.planmeca.com](http://online.planmeca.com) for downloading the Planmeca Romexis LabApp application.

# Access to unique X-ray device data

*Take the efficiency of your clinic to the next level with real-time information on networked equipment usage and events. Our digital tools offer several quality assurance and service benefits for local users and also allow you to remotely monitor your clinic from anywhere.*

Planmeca equipment can be networked to gather valuable data on their use.

- Detailed X-ray log book with dosage and sensor information
- Meet regulatory requirements with automatic recording of image exposure values: kV and mAs
- Enhanced operational planning – exposure counts and modality distribution
- Enhance operational planning – usage hours
- Use detailed event logs to improve quality assurance – including radiation hygiene
- Maximise equipment uptime with fast and accurate trouble-shooting



## Stand out with colour

Complement the design of your Planmeca ProMax® 3D X-ray unit by giving it a personal touch with your favourite colour.



## Technical specifications

### Technical data

	Viso G3*	Viso G5	Viso G7	ProMax 3D Classic	ProMax 3D Plus	ProMax 3D Mid
Anode voltage	60–120 kV	60–120 kV	60–120 kV	60–90 kV	60–90 kV 60–120 kV	60–90 kV 60–120 kV
Anode current	1–16 mA	1–16 mA	1–16 mA	1–14 mA	1–14 mA	1–14 mA
Focal spot	0.5 mm, fixed anode	0.5 mm, fixed anode	0.5 mm, fixed anode	0.5 mm, fixed anode	0.5 mm, fixed anode	0.5 mm, fixed anode
Image detector	Flat panel	Flat panel	Flat panel	Flat panel	Flat panel	Flat panel
Image acquisition	200 / 360 degree rotation	200 / 360 degree rotation	200 / 360 degree rotation	Single 200 degree rotation	200 / 360 degree rotation	200 / 360 degree rotation
Scan time	1–36 s	1–36 s	1–36 s	9–37 s	9–33 s	9–33 s
Typical reconstruction time	2–55 s	2–55 s	2–55 s	2–25 s	2–30 s	2–55 s

CE 0598 MD Planmeca Viso

CE 0598 MD Planmeca ProMax 3D

CE 0598 MD Planmeca ProMax 3D Plus

CE 0598 MD Planmeca ProMax 3D Mid

### Comparison

	Viso G3	Viso G5	Viso G7	ProMax 3D Classic	ProMax 3D Plus	ProMax 3D Mid
Planmeca Ultra Low Dose™ imaging	Yes	Yes	Yes	Yes	Yes	Yes
Tube voltage	120 kV	120 kV	120 kV	90 kV	90 kV/120 kV	90 kV/120 kV
Endodontic mode	Yes	Yes	Yes	Yes	Yes	Yes
3D dental programs	Yes	Yes	Yes	Yes	Yes	Yes
3D ENT programs	Yes	Yes	Yes	-	Yes	Yes
Child mode	Yes	Yes	Yes	Yes	Yes	Yes
3D face photo	Yes	Yes	Yes	Yes	Yes	Yes
3D model scan	-	-	-	Yes	Yes	Yes
SureSmile certification	-	-	-	Yes	Yes	Yes
2D panoramic imaging	Yes	Yes	Yes	Yes	Yes	Yes
Cephalometric imaging, scanning	-	-	-	Yes	Yes	Yes
Cephalometric imaging, one-shot	Yes	Yes	Yes	Yes	Yes	Yes

\*Planmeca Viso G3 pending CE mark approval.

## Volume sizes

Volume size [cm]

	Viso G3	Viso G5	Viso G7	ProMax 3D Classic	ProMax 3D Plus	ProMax 3D Mid
<b>Maximum volume sizes</b>						
Maximum volume with a single scan	Ø20 x 10	Ø20 x 10	Ø30 x 20	Ø8 x 8	Ø20 x 10	Ø20 x 10
Extended volume with a single scan				Ø11 x 8		
Maximum volume with multiple horizontal scans				15 x 10 x 8		
Maximum volume with multiple vertical scans		Ø20 x 17	Ø30 x 30			Ø20 x 17
<b>Dental programs</b>						
Tooth	Ø3 x 3 – Ø6 x 6	Ø3 x 3 – Ø6 x 6	Ø3 x 3 – Ø6 x 6	Ø5 x 5 Ø5 x 8	Ø4 x 5 Ø4 x 8	Ø4 x 5 Ø4 x 8
Teeth	Ø7 x 3 – Ø9 x 9	Ø7 x 3 – Ø9 x 9	Ø7 x 3 – Ø12 x 10	Ø8 x 5 Ø8 x 8	Ø8 x 5 Ø8 x 8 Ø10 x 6 Ø10 x 10	Ø8 x 5 Ø8 x 8 Ø10 x 6 Ø10 x 10
extended volume				Ø11 x 5 Ø11 x 8		
double scan				2x Ø8 x 8		
triple scan				3x Ø8 x 8		
Jaw	Ø10 x 3 – Ø20 x 10	Ø10 x 3 – Ø20 x 10	Ø13 x 3 – Ø17 x 17		Ø16 x 6 Ø16 x 10 Ø20 x 6 Ø20 x 10	Ø16 x 6 Ø16 x 10 Ø20 x 6 Ø20 x 10
Face		Ø14 x 13 – Ø20 x 17	Ø14 x 12 – Ø30 x 20			Ø16 x 16 Ø16 x 9 Ø20 x 10 Ø20 x 17
Skull			Ø20 x 22 – Ø30 x 30			
<b>ENT (Ear, Nose, Throat) programs</b>						
Nose	Ø7 x 5 – Ø9 x 9	Ø7 x 5 – Ø9 x 9	Ø7 x 5 – Ø12 x 10		Ø8 x 8	Ø8 x 8
Sinus	Ø10 x 11 – Ø20 x 10	Ø10 x 11 – Ø20 x 15	Ø10 x 10 – Ø17 x 20		Ø10 x 10 Ø16 x 10 Ø20 x 10	Ø10 x 8 Ø10 x 10 Ø10 x 14 Ø16 x 8 Ø16 x 10 Ø16 x 14 Ø20 x 8 Ø20 x 10 Ø20 x 14
Middle ear	Ø3 x 3 – Ø6 x 6	Ø3 x 3 – Ø6 x 6	Ø3 x 3 – Ø6 x 6		Ø4 x 5 Ø8 x 8	Ø4 x 5 Ø8 x 8
Temporal bone	Ø7 x 5 – Ø9 x 9	Ø7 x 5 – Ø9 x 9	Ø7 x 5 – Ø12 x 10		Ø8 x 8	Ø8 x 8
Vertebrae	Ø9 x 8 – Ø11 x 10	Ø9 x 8 – Ø11 x 10	Ø8 x 8 – Ø10 x 14		Ø8 x 8	Ø8 x 8
Airways	Ø9 x 8 – Ø11 x 10	Ø9 x 8 – Ø11 x 10	Ø8 x 8 – Ø10 x 14		Ø8 x 8	Ø8 x 8

## Voxel sizes

Planmeca Viso: 75 µm\*\*, 150 µm, 300 µm, 450 µm, 600 µm

Planmeca ProMax 3D: 75 µm\*\*, 100 µm, 150 µm, 200 µm, 400 µm, 600 µm

\*\*Requires Endodontic imaging licence.

# Technical specifications

## Recommended space requirements

- ProMax 3D Classic
- ProMax 3D Plus or 3D Mid
- Viso G3, Viso G5 or Viso G7

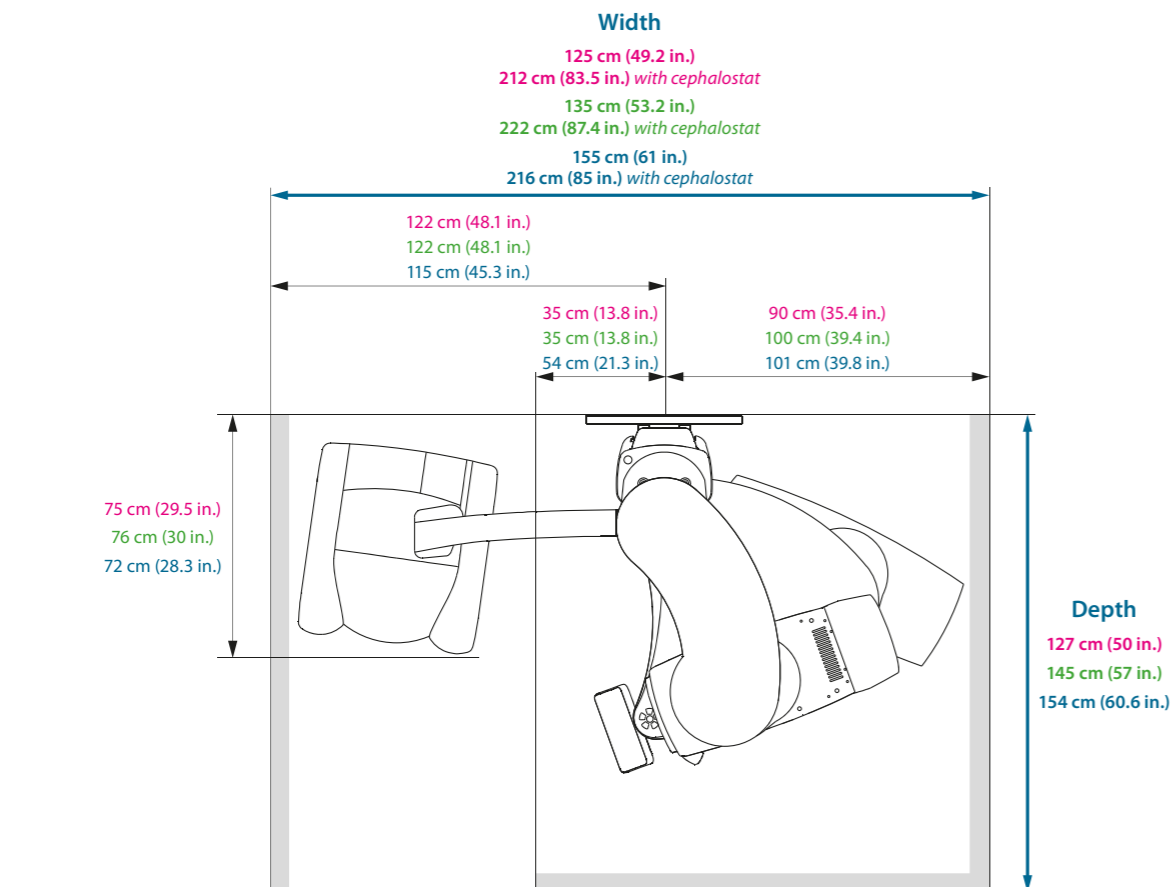
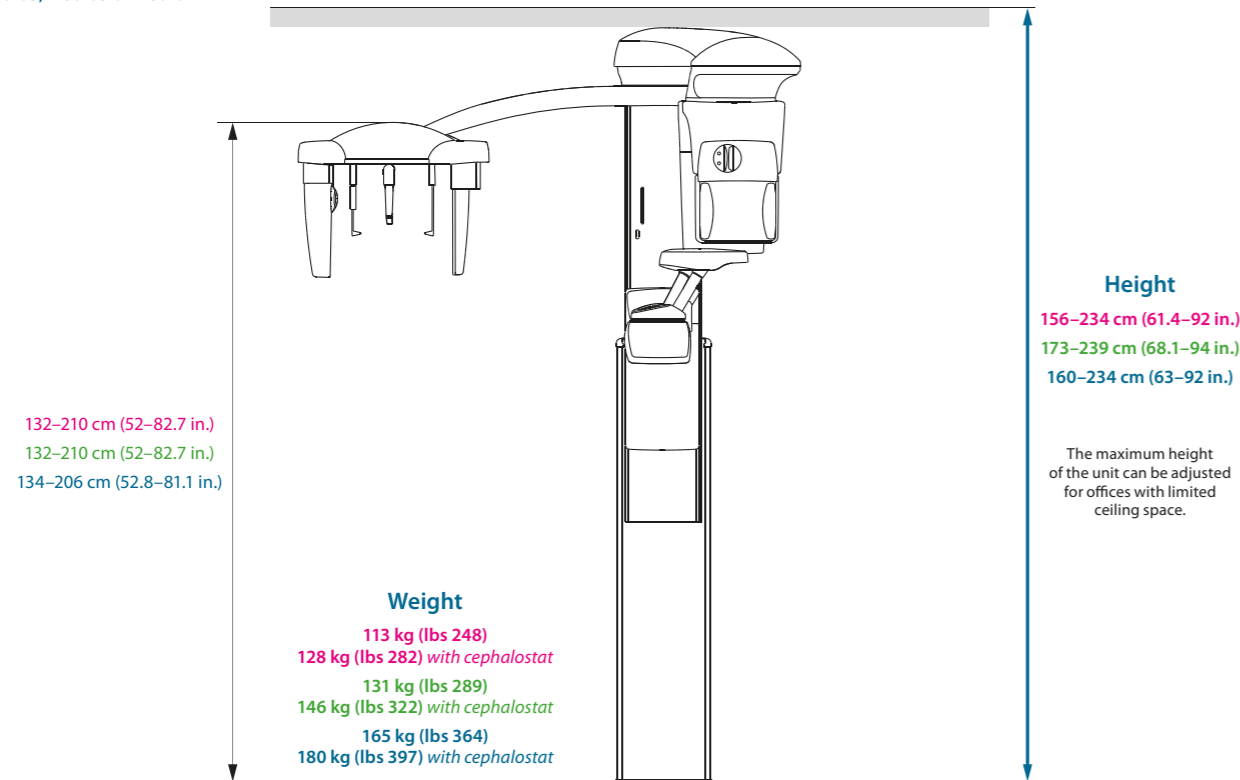

## Planmeca Romexis® imaging software

Supported 2D modalities	Intraoral Panoramic Cephalometric 2D linear tomography Photos Stack images (CBCT slices and panoramic slices)
Supported 3D modalities	3D CBCT 3D photo 3D surface scan
Supported photo sources	Intraoral camera Digital camera or scanner (import or TWAIN capture)
Image formats	JPEG or TIFF (2D images) DICOM (2D and 3D images) STL, OBJ, PLY (3D surface models) DICOM, TIFF, JPEG, PNG, BMP, STL, PLY (imports/exports)
Image size	2D X-ray image: 1–9 MB 3D X-ray image: typically 50 MB–1 GB
Installation options	Client–Server
DICOM 3.0 support	DICOM Import and Export DICOM DIR Media Storage
Interfaces	TWAIN Client PMBridge (patient information and images) VDDS (patient information and images) InfoCarrier (patient information)
3 <sup>rd</sup> party software integrations	Dolphin Imaging NobelClinician Simplant Straumann coDiagnostiX Cybermed N-Liten 3D Diagnostics service 360imaging service
System requirements	See planmeca.com 

CE 0598 MD Planmeca Romexis

## Find all the latest Planmeca news



[www.facebook.com/PlanmecaOy](https://www.facebook.com/PlanmecaOy)



[www.instagram.com/planmeca\\_official](https://www.instagram.com/planmeca_official)



[www.planmeca.com/newsroom](https://www.planmeca.com/newsroom)



Planmeca Oy designs and manufactures a full line of industry-leading dental equipment, including 3D and 2D imaging devices, CAD/CAM solutions, dental care units and software. Planmeca Oy, the parent company of the Finnish Planmeca Group, is strongly committed to better care through innovation, and it is the largest privately held company in the field.

Follow us on social media!



# PLANMECA

Asentajankatu 6 | 00880 Helsinki | Finland | tel. +358 20 7795 500 | fax +358 20 7795 555 | sales@planmeca.com | www.planmeca.com

Images may contain optional items not included in standard delivery. Available configurations and features may have country or area specific variations. Some products displayed above may not be available in all countries or areas. Rights for changes reserved.

Planmeca, All in one, Anatomat Plus, Cobra, Comfy, Digital perfection, Economat Plus, Elegant, Flexy, Perio Fresh, PlanEasyMill, Planmeca 4D, Planmeca AINO, Planmeca ARA, Planmeca CAD/CAM, Planmeca CALM, Planmeca Curiosity, Planmeca Chair, Planmeca Clarify, Planmeca Compact, Planmeca ConBo, Planmeca CORE, Planmeca Creo, Planmeca Emerald, Planmeca FIT, Planmeca Imprex, Planmeca Intra, Planmeca iRomexis, Planmeca Lumion, Planmeca Lumo, Planmeca Maximity, Planmeca Minea, Planmeca Minendo, Planmeca Minetto, Planmeca mRomexis, Planmeca Noma, Planmeca Olo, Planmeca Online, Planmeca Piezon, Planmeca PlanCAD, Planmeca PlanCAM, Planmeca PlanClear, Planmeca PlanDesk, Planmeca PlanID, Planmeca PlanMill, Planmeca Planosil, Planmeca PlanPure, Planmeca PlanScan, Planmeca PlanView, Planmeca Pro50, Planmeca ProCeph, Planmeca ProFace, Planmeca ProID, Planmeca ProMax, Planmeca ProModel, Planmeca ProOne, Planmeca ProScanner, Planmeca ProSensor, Planmeca ProX, Planmeca Romexis, Planmeca Serenus, Planmeca SingLED, Planmeca SmartGUI, Planmeca Solanna, Planmeca Sovereign, Planmeca Ultra Low Dose, Planmeca Verity, Planmeca Vision, Planmeca Viso, Planmeca Waterline Cleaning System, Planmeca Xtremity, Proline Dental Stool, ProTouch, SmartPan, SmartTouch, Trendy, and Ultra Relax are registered or non-registered trademarks of Planmeca in various countries.

10032799/0923/en